

# Garage D 40 (575x510)

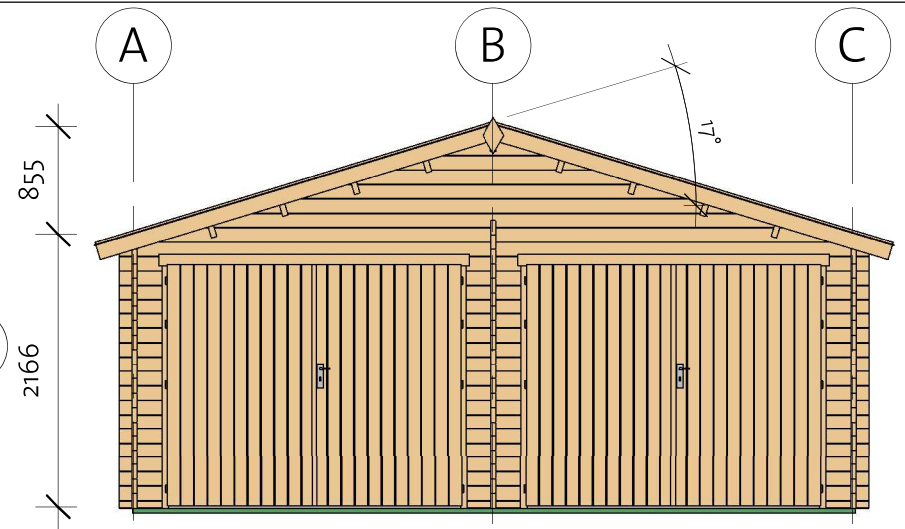

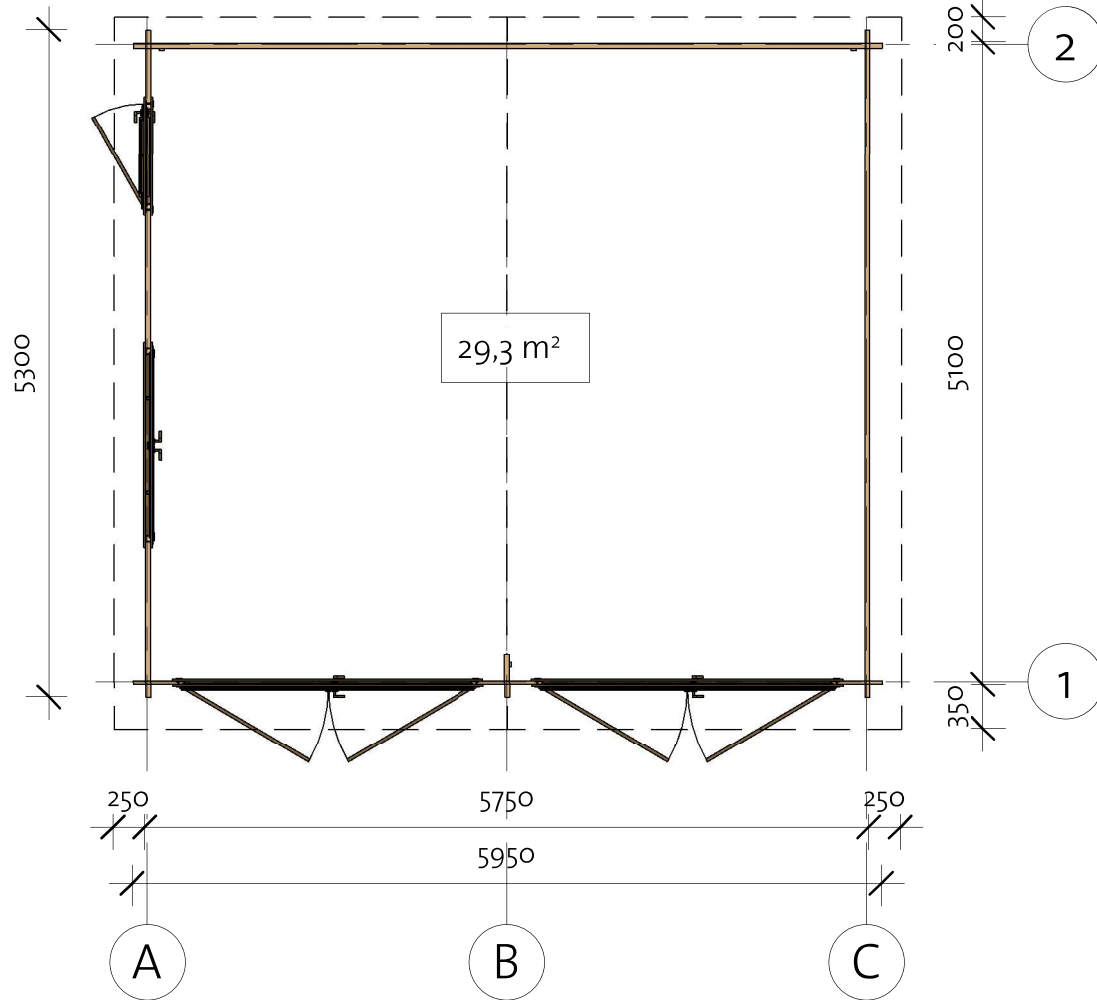
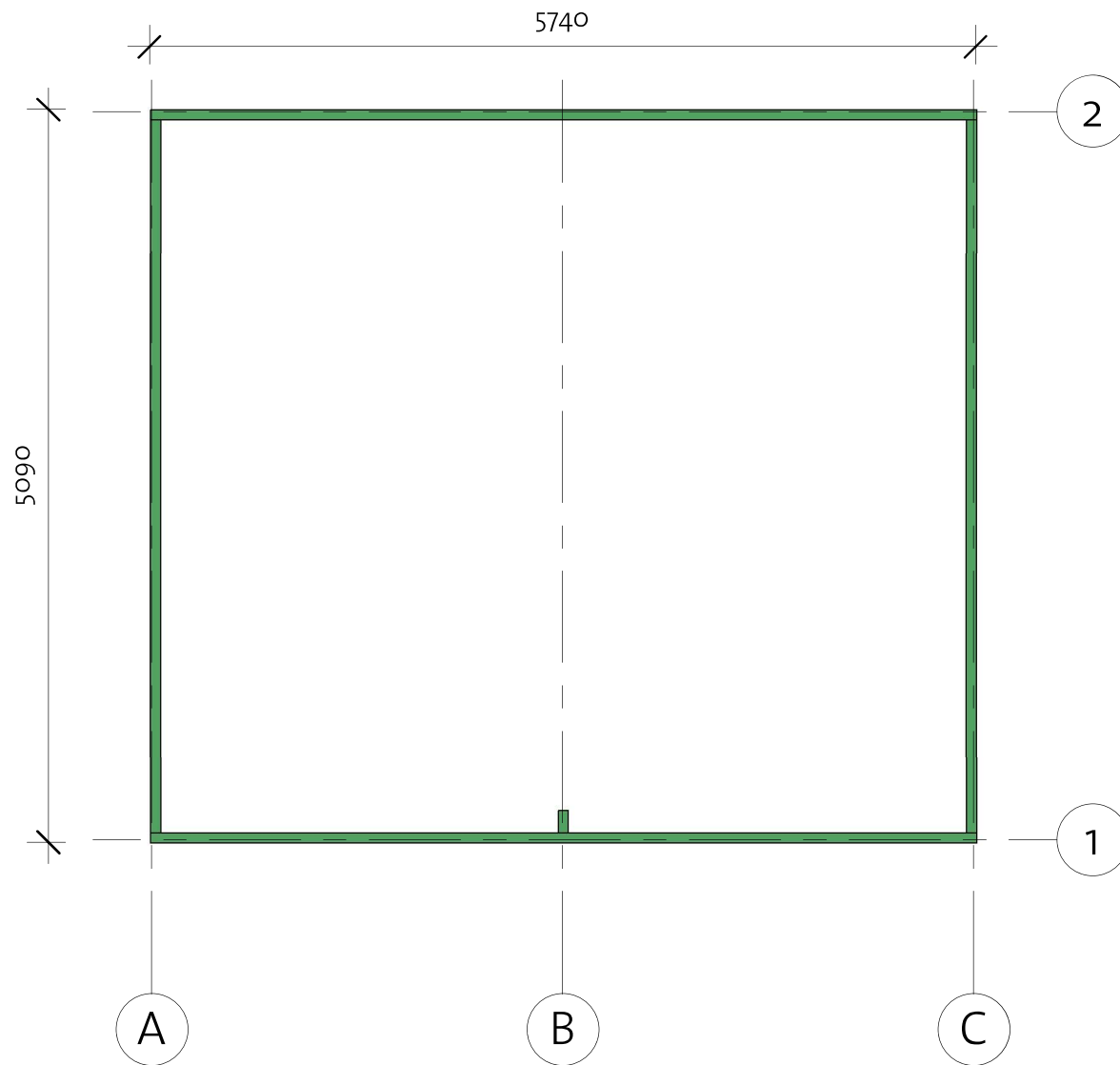

# Garage D 40 (575x510)

Foundation



## Impregnated foundation beams

Mark	Type	Profile	Count	Length
IFB1	IFB 70x40		2	5740
IFB2	IFB 70x40		2	4950
IFB3	IFB 70x40		1	160

# Garage D 40 (575x510)

Wall 1

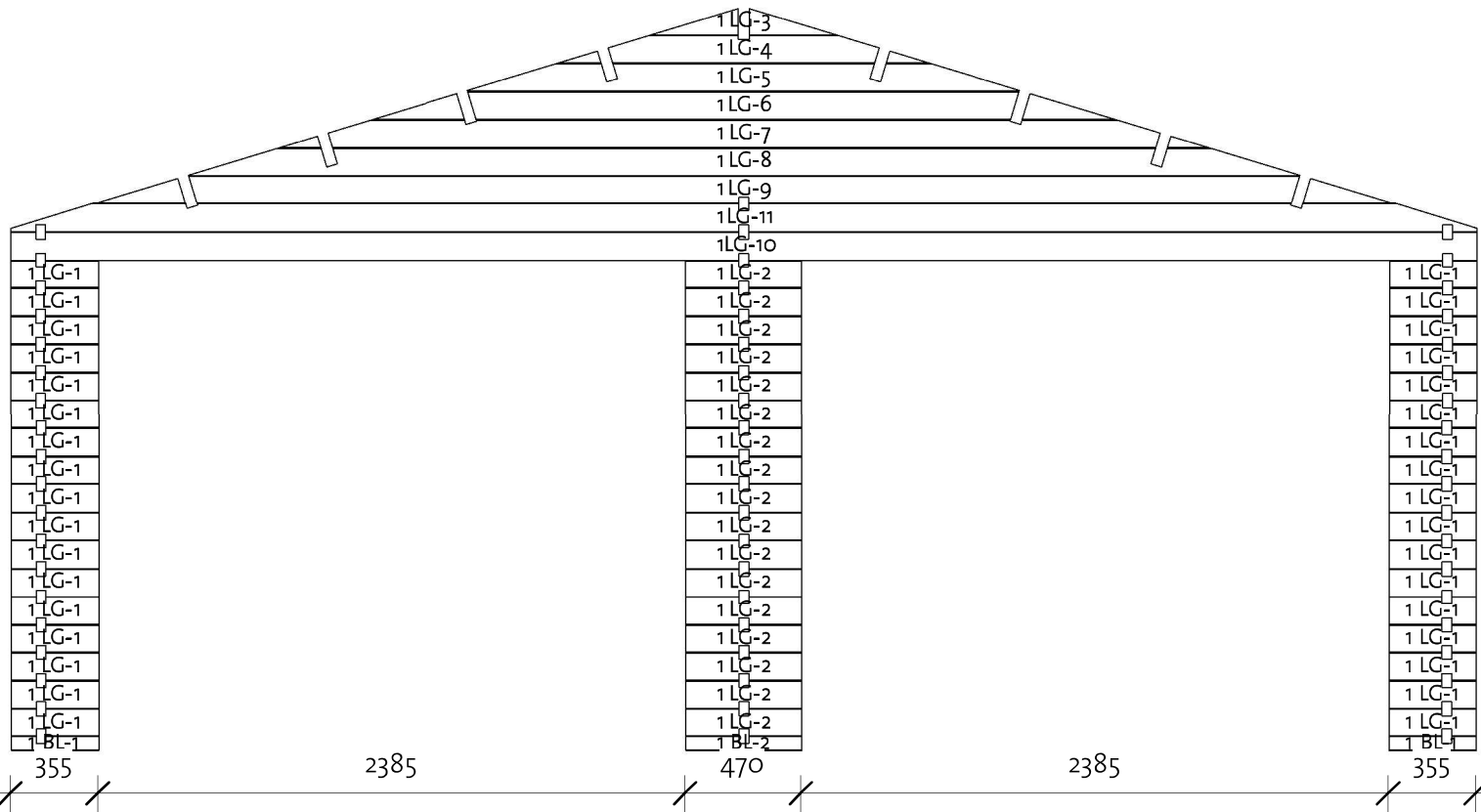
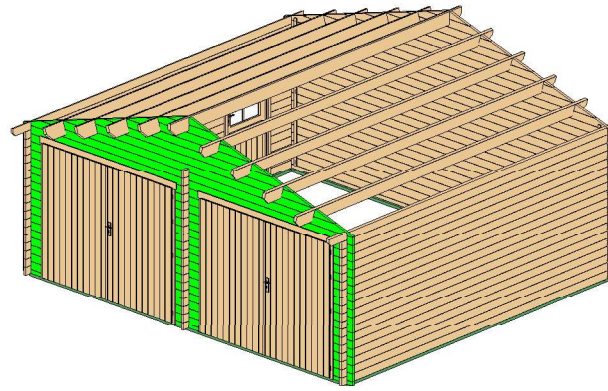



Wall 1			
Mark	Profile	Count	Cut Length

1BL-1	40X57	2	355
1BL-2	40X57	1	470
1LG-1	40X114	34	355
1LG-2	40X114	17	470
1LG-3 *	40X114	1	759
1LG-4 *	40X114	1	1514
1LG-5 *	40X114	1	2240
1LG-6 *	40X114	1	3026
1LG-7 *	40X114	1	3781
1LG-8 *	40X114	1	4513
1LG-9 *	40X114	1	5292
1LG-10	40X114	1	5950
1LG-11 *	40X114	1	5950

\* Gable - delivered premounted

Log Profile Wall 1	
Profile	Profile

40X57	
40X114	

# Garage D 40 (575x510)

Wall 2

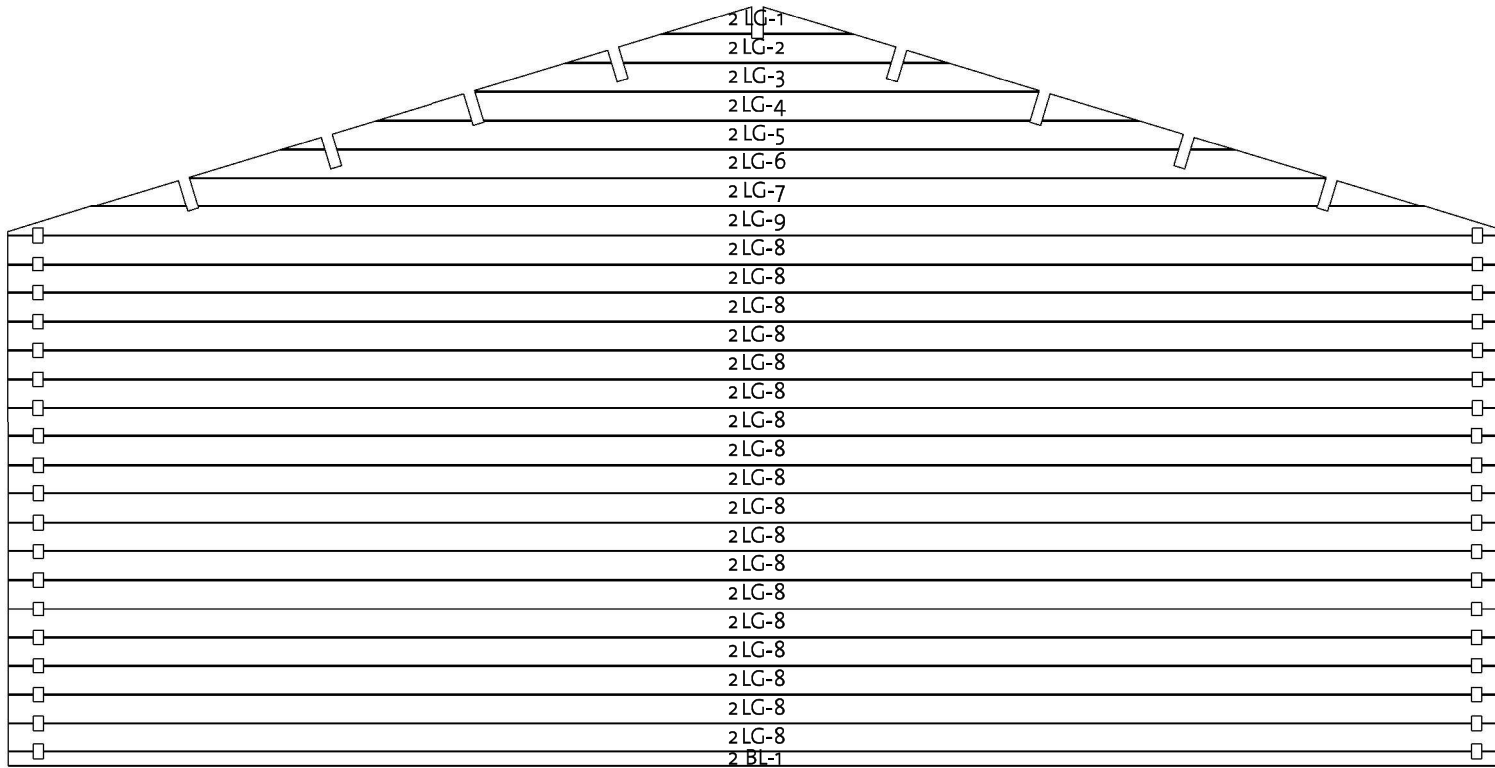
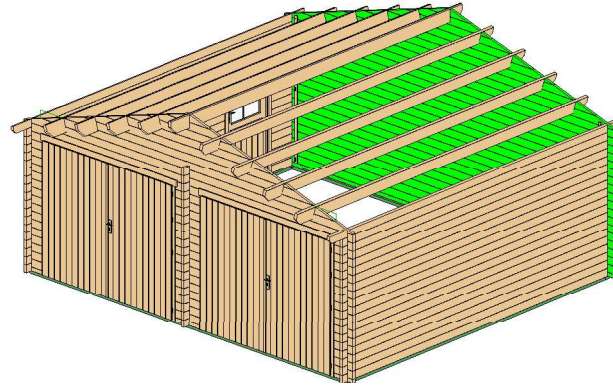



Wall 2			
Mark	Profile	Count	Cut Length

2BL-1	40x57	1	5950
2LG-1*	40x114	1	759
2LG-2*	40x114	1	1514
2LG-3*	40x114	1	2240
2LG-4*	40x114	1	3026
2LG-5*	40x114	1	3781
2LG-6*	40x114	1	4513
2LG-7*	40x114	1	5292
2LG-8	40x114	18	5950
2LG-9*	40x114	1	5950

\* Gable - delivered premounted

Log Profile Wall 2	
Profile	Profile

40x57	
40x114	

# Garage D 40 (575x510)

Wall A

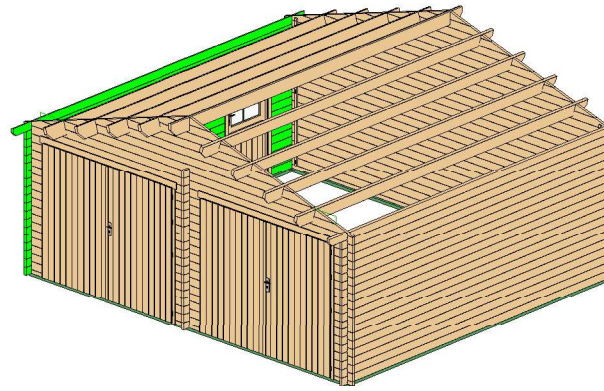

Wall A			
Mark	Profile	Count	Cut Length

ALG-1	40X114	17	575
ALG-2	40X114	9	1098
ALG-3	40X114	9	1238
ALG-4	40X114	8	3875
ALG-5	40X114	1	5300
ATL-1	40X114	1	5650

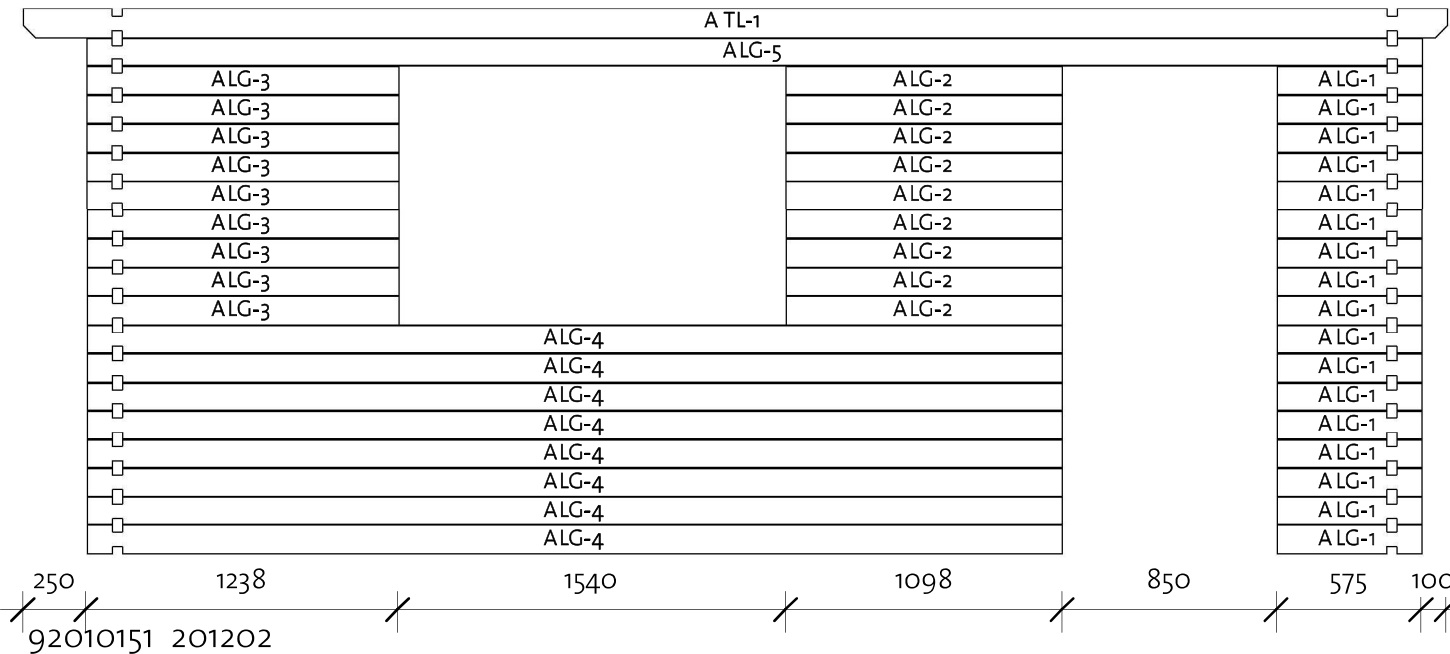

Log Profile Wall A	
Profile	Profile

40X114	
40X114	

# Garage D 40 (575x510)

Wall B / C

Log Profile Wall B	
Profile	Profile

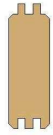
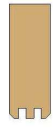
40X114	
40X114	

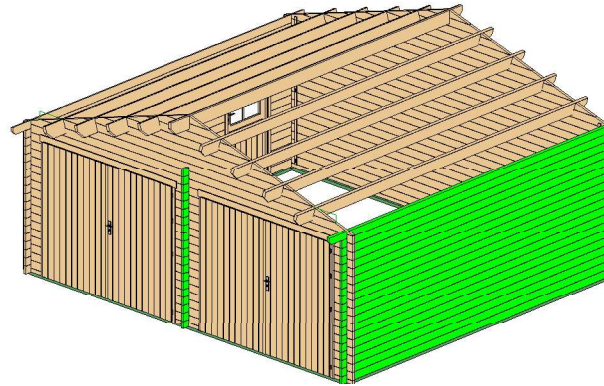

Wall C			
Mark	Profile	Count	Cut Length

CLG-1	40X114	18	5300
CTL-1	40X114	1	5650

Wall B			
Mark	Profile	Count	Cut Length

BLG-1	40X114	19	350
BLG-2	40X114	1	350

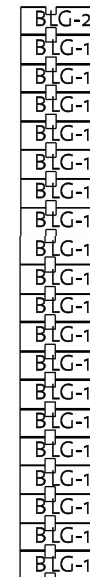
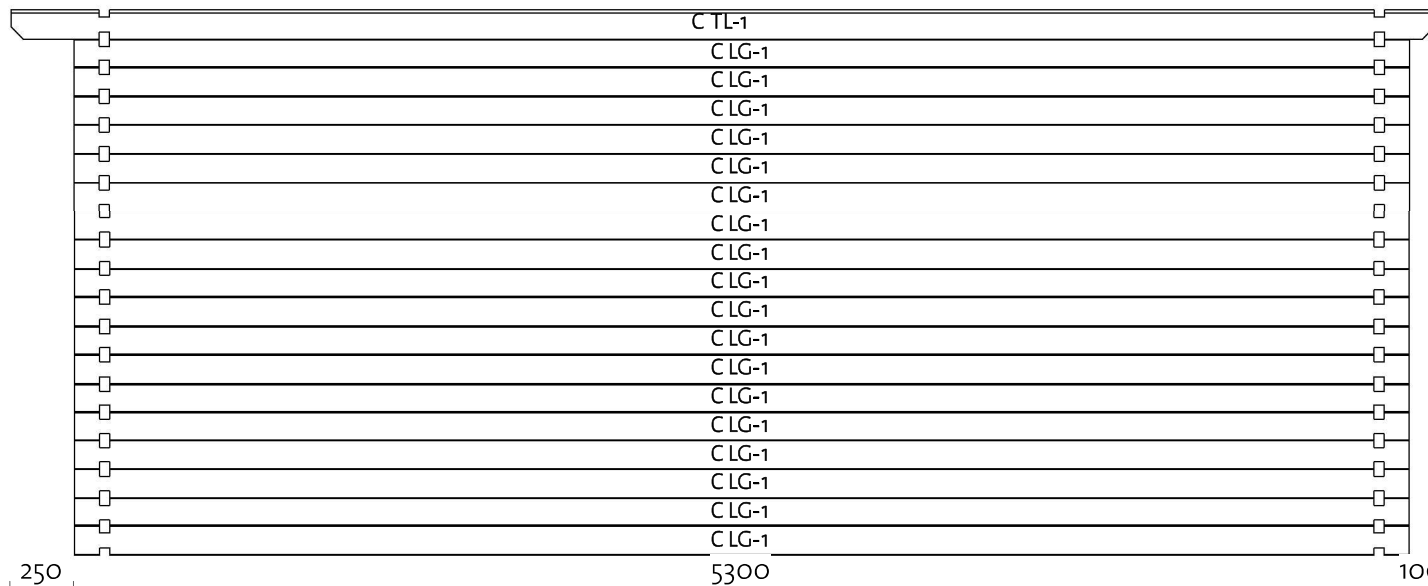

Log Profile Wall C	
Profile	Profile

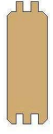
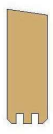
40X114	
40X114	



250  
92010151\_201202

100

# Garage D 40 (575x510)

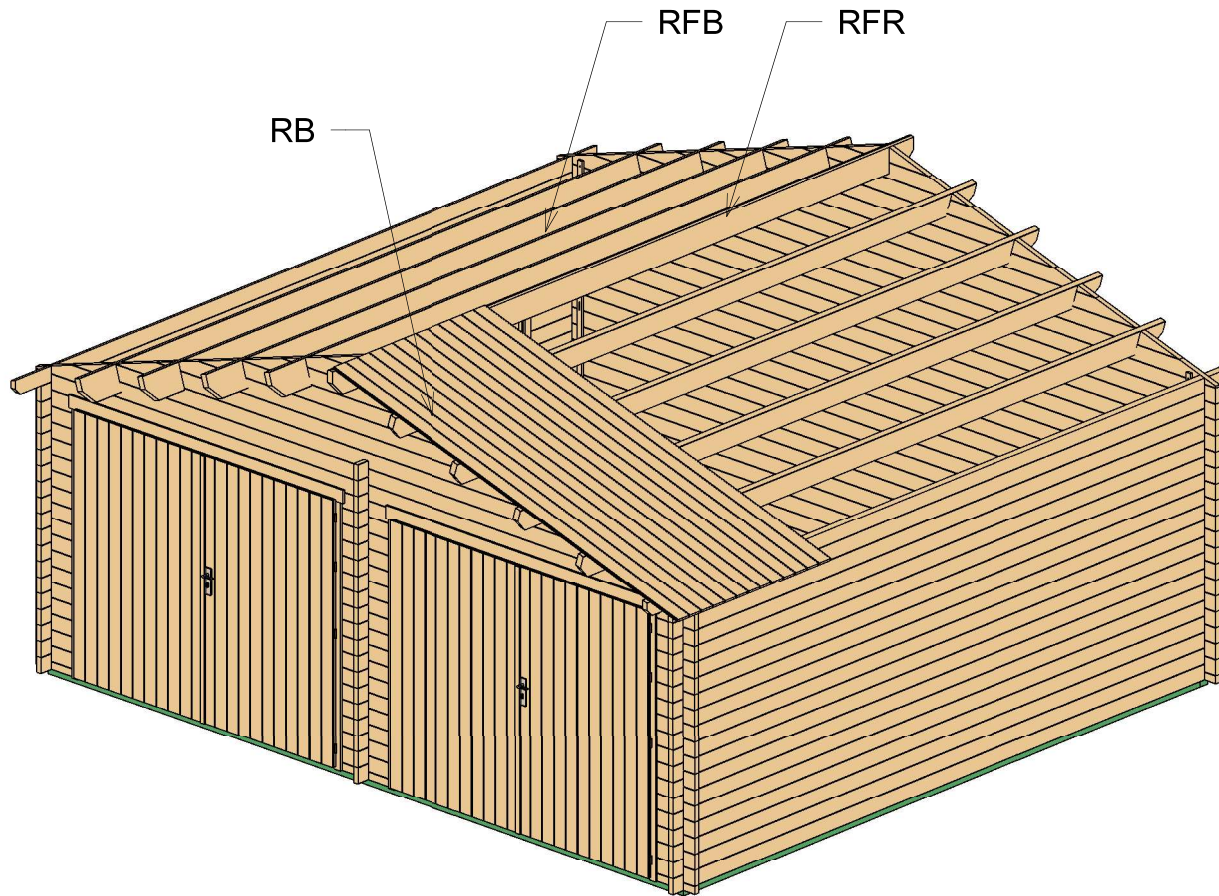
Roof 1



Roof				
Mark	Type	Profile	Count	Length
RFR	Ridge 45x195		1	5650
RFB	Beam 45x195		8	5650
RB	17x114		102	3259

# Garage D 40 (575x510)

Roof 2



2) Facia

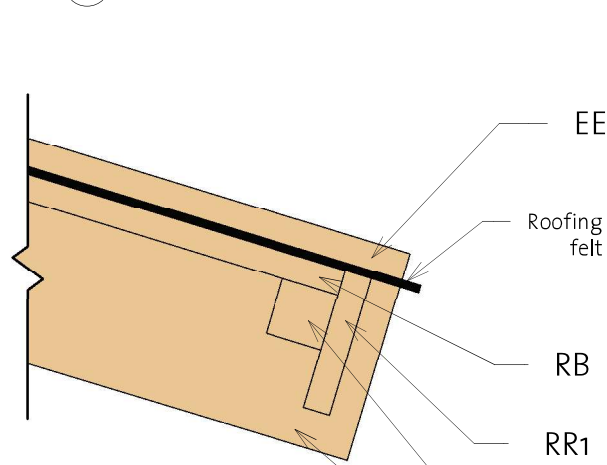

3) Roof Reinforcement

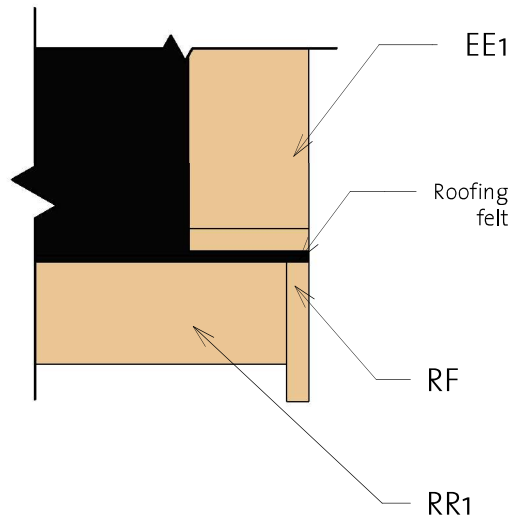
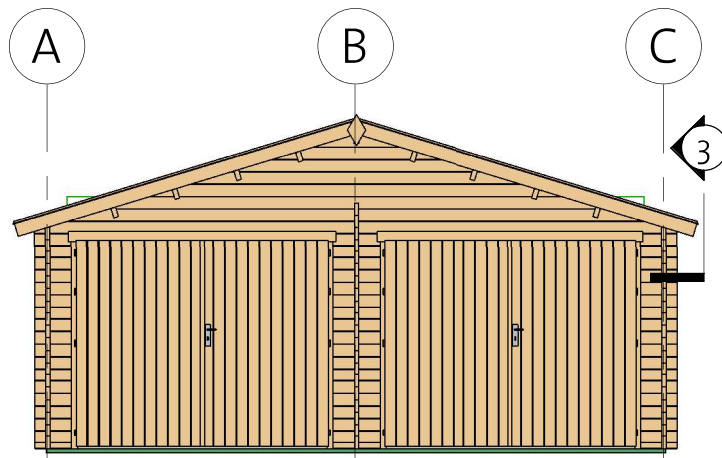

Fascia Schedule

Mark	Type	Profile	Count	Length
EE	Eave Edging 18x95		4	3302
RF	Roof Fascia 18x120		4	3302
RR1	Roof reinforcement 18x95		2	5650
RR2	Roof reinforcement 38x38		2	5650



# Garage D 40 (575x510)

Extras









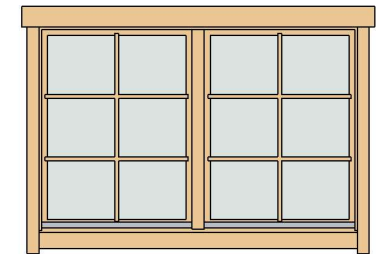

CD1R	Classic door 1 right	840	1890	1
CDD10R	Classic double door 10, wood right	2370	1955	2

DCB6	Door Crossbar 6	--	--	1
------	--------------------	----	----	---

CDW1	Classic double window 1	1530	990	1
------	----------------------------	------	-----	---

WCB6	Windows Crossbar 6	--	--	2
------	-----------------------	----	----	---



Hitblock	300-400 mm		
Door bolt	315 x 65		2
Screws	5,0 x 70		15
Bolts	M8x70		15
Screws	5,0 x 40		16
Screws	6,0 x 140		63
Screws	4,0 x 40		110
Screws	4,0 x 50		670

Type	Count	Length
------	-------	--------

Windboard 18x40	5	2200
--------------------	---	------

Type	Count
------	-------



Romb	2
------	---







# Garage D 40 (575x510)

## List of all items 1



### Impregnated foundation beams

Mark	Type	Profile	Count	Length
IFB1	IFB 70x40		2	5740
IFB2	IFB 70x40		2	4950
IFB3	IFB 70x40		1	160

### Fascia Schedule

Mark	Type	Profile	Count	Length
EE	Eave Edging 18x95		4	3302
RF	Roof Fascia 18x120		4	3302
RR1	Roof reinforc ement 18x95		2	5650
RR2	Roof reinforc ement 38x38		2	5650

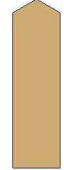
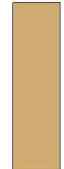
### Roof

Mark	Type	Profile	Count	Length
RFR	Ridge 45x195		1	5650
RFB	Beam 45x195		8	5650
RB	17x114		102	3259

# Garage D 40 (575x510)

## List of all items 2

Wall 1			
Mark	Profile	Count	Cut Length

1BL-1	40X57	2	355
1BL-2	40X57	1	470
1LG-1	40X114	34	355
1LG-2	40X114	17	470
1LG-3 *	40X114	1	759
1LG-4 *	40X114	1	1514
1LG-5 *	40X114	1	2240
1LG-6 *	40X114	1	3026
1LG-7 *	40X114	1	3781
1LG-8 *	40X114	1	4513
1LG-9 *	40X114	1	5292
1LG-10	40X114	1	5950
1LG-11 *	40X114	1	5950

Wall A			
Mark	Profile	Count	Cut Length

ALG-1	40X114	17	575
ALG-2	40X114	9	1098
ALG-3	40X114	9	1238
ALG-4	40X114	8	3875
ALG-5	40X114	1	5300
ATL-1	40X114	1	5650

Wall 2			
Mark	Profile	Count	Cut Length

2BL-1	40X57	1	5950
2LG-1 *	40X114	1	759
2LG-2 *	40X114	1	1514
2LG-3 *	40X114	1	2240
2LG-4 *	40X114	1	3026
2LG-5 *	40X114	1	3781
2LG-6 *	40X114	1	4513
2LG-7 *	40X114	1	5292
2LG-8	40X114	18	5950
2LG-9 *	40X114	1	5950

\* Gable - delivered premounted

Wall B			
Mark	Profile	Count	Cut Length

BLG-1	40X114	19	350
BLG-2	40X114	1	350

Wall C			
Mark	Profile	Count	Cut Length

CLG-1	40X114	18	5300
CTL-1	40X114	1	5650

Log profiles	
Profile	Profile

40X57	
-------	---

Log profiles	
Profile	Profile

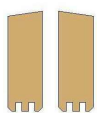
40X114	
--------	---

Log profiles	
Profile	Profile

40X114	
--------	--

Log profiles	
Profile	Profile

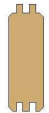
40X114	
--------	---